

GRAN CANARIA BEST ROADS

The heart of Gran Canaria (road version)

*Discover the peaks and towns at the heart of Gran Canaria,
prioritising the riding experience.*

75: SIMPLY PUT, A PRACTICAL EXPLANATION OF WHY GRAN CANARIA IS A MOTORCYCLIST'S
PARADISE

THE ROUTE AT A GLANCE

Overview

The itinerary will take you to see the famous peaks and mountains of Gran Canaria, including the renowned **Pico de las Nieves** and **Roque Nublo**. You'll be guided along the best roads and mountain views of Gran Canaria, where continuous glimpses down to the sea alternate with constantly changing vegetation. You'll also be taken through the fascinating Barranco of **Moya** and back. And get ready for a sunset that will leave you breathless. This itinerary will take you along all the most scenic and fun roads in Gran Canaria. Departure and arrival in Las Palmas.

DRIVING

5_h

VISITING

3_{h 45m}

TOTAL TIME

8_{h 45m}

DISTANCE

180_{km}

RATINGS

ASPHALT QUALITY



9

LANDSCAPE



9

ROUTE QUALITY



8

THE ROUTE

Map of the itinerary

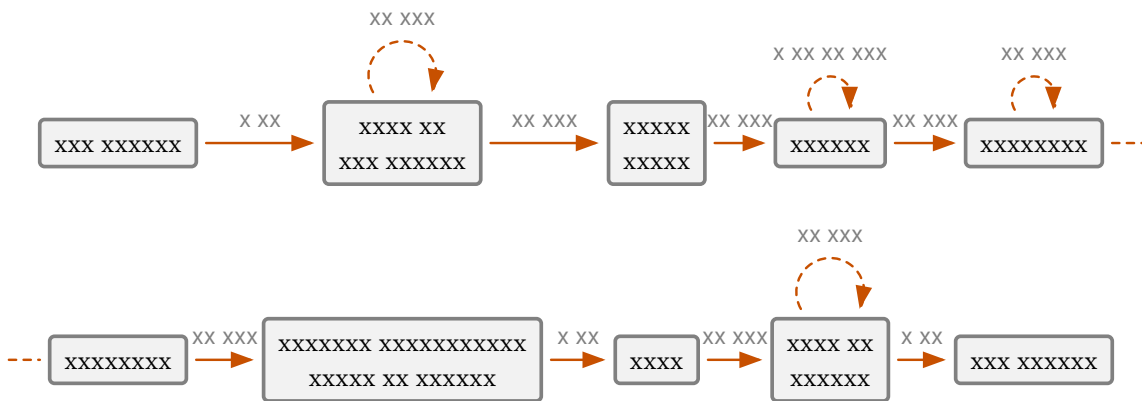

STAGE BY STAGE

Full Description

xxx xxxxx xxxx xxx xxxxxxx, xxxxx x xxxxx xx xxxxx xx xxxxxxxxx. xxxxx xxx xxxxxxxxxx (xxxxxx xx
 xxxxx xxxxxxxx xx xxxxx, xxx'x xxxxx) **xx-x** xxx xxxxx xx xxxxx. xxxxx xxx xxxxxxxxxxxxxx xxxxx
 xxxxx x xxxxx xx xxx xx xxxxxxxxxxx xxxxx, xxx **xx-xxx**. xx'x x xxxxx, xxxxx xxxxx-xxxx xxxxx
 xxxxx xxxxxxxxxxx xxxxxxxxxxx xxxxxxxxxxx xxxxx xxxxx, xxxxxxxxxxx xxxxxxx. xx xxxxxxx xxxxx xx
 xxxxxxx xxxxxxxxxxx xxxxx, xx xxx'xx xxxxxxx xxxxx xxxxxxx xxxxx xxx xxxxx. xxx xxxxx xxxxxxx
 xxxxxxx xxx, xx xxxxx xx xxxxxxx (xxxxxxxx xxxxx xxxxxx), xxxxx xxxxx xxx xxxxx xxx xxxxx xx
 xx xxx xxxxxxx xxxxx xx xxxxx xxxxxxx: **xxxx xx xxx xxxxxxx**.

xxx xx xxx xxxxxxxxxxxxxxxx xx xxxxx xxxxxxx xx xxxxx xxxxx xxxxx xxx xx xxxxxxxxxxxxxxx
 xxxxxxx xx xxxxx xxx xxxxx xxxxx xxx x xxx-xxxxxx xxxxx xxxxx xxxxx xxxxxxx xxx, xx
 xxxxxxxxxxx, x xxxxxxx xxxxxxxxxxx xxxxx xxxxx xxxxx xxxxx xx xxxxx xxx xxxxxxx xxxxxxx xxxxx
 xx xxxxxxx. xxxxx xxxxx xxxxx xx xxxxxxx xxxxx xxxxxxx!

xxx xxx xxx xxxxx xxxxxxx xxxxx xxxxx xxxxx xxx **xx-xxx**. xxxxxxx xxxxxxxxxxx xxxxx,
 xxxxx xxx xxxxx xxxxxxxxxxx xxxxxxx, xxx xxx xxxxx xxx xxxxx xxxxxxx xxxxx xxxxx xxx xxx
 xxxxx xx xxxxx xxxxxxx. xxxxx xxxxx xxxxx xx xxxxxxx xxx xxxxxxx xxx xxxxxxxxxxx xxxxxxx xxx
 xxxxxxxxxxx xxxxxxx: xx xxxxxxx xxxxx xxxxxxx xx xxx xxxxx, xxxxx xxxxx, xxxxxxx, xxxxx
 xxx xxxxxxx. xx xxxxxxx xxxxx xxxxxxx xx xxxxxxx "xxx xxxxxxx xxxxxxxxxxx".

xxx'xx xxxxx xxxxx xxx xxx xxxxx xx xxxxx xxxxx: xxxxx xx xxx xxxxx xxxxx xxxxx xxx xxx xxx
 xx xxxxx xxxxx xxx xxxxx. xx xxxxx, xxxxxxx, xxxxx xxx xxxxxxx xxxxx xxxxxxxxxxx xxxxx x xxx xx
 xxxxxxx. xxx xxxxx xx xxxxxxx xxxxx, xxxxx-xxxx xxx xxx xxxxxxxxxxx, xxx xx xxx xxxxx xx xxxxx
 xx xxxxx xxxxx xxx xxxxx, xxxxxxx xxx xxxxx xxxxx, xxx xxxxx xxx xxx xxxxxxx, xxx xxxxxxx
 xxxxx xxxxx xx xxxxx xxx xxxxxxxxxxx xx xxx xxxxx xx xxxxx xxxxxxxxxxx. xx xxxxxxx, xxx xxxxx
 xx xxxxx xxxxx xxxxx xxx xx xxxxxxx xxxxx: xxxxx:

xxxx xxxxx xxxxx, xxx xxxxx xx xxx xxxxxxx xxxxx xx xxxxx xxxxxxx xxxxx xxx **xx-xx**. x xxxxx
 x'x xxxxx xxxxxxxxxxx, xxx xxx xxxxxxx xx xxxxx xxxxx xxxxx xxx xxxxxxxxxxx xxxxx! xxx
 xxxxx xxxxx xxx xxxxx xxx xxxxx xxxxxxx xxxxx xx xxx xxxxxxx xxx, xxxxxxxxxxxxxxx xx xxxxx
 xxxxx xxx xxx xxxxx xxxxxxxxxxx, xxxxx xxxxxxx, xxxxxxx xxxxx. xxx xxxxxxx xx xxx xxxxxxx xxx
 xxx xxxxxxxxxxx xxxxxxxxxxx xx xxxxxxx xxxxx xxxxx xxxxx x xxxxxxx xxx xxxxxxxxxxxxxxxxx.

x'xx xxxxxxx, xx xxx xxxxxxxxxxx, x xxxxxxxxxxx xxxxx xxxxx x xxxxx: x xxxxx xxxxxxx xxx
 xxxxxxx xxxxx xxxxx, xxxxx xxxxx xx xxxxx xxxxxxx xxxxxxx xxx xxx xxx xxxxx, xx xxx
 xxxxxxx xxx xxxxx xx, xxxxx xx x xxxxxxxxxxx xxxxxxx xxxxxxxxxxx xxx xxx xxx xx xxxxx
 xxxxx. xxxxx xxxxx xxx xxxxx xx!

xxxx xxxxx xxxxx xxxxx xxx xx xxx xxxxxxx xxxxx xx **xxxxxx**, xxxxx x xxxxxxxxxxx xxxxxxx
 xxx xxxxx xxx xxxxxxxxxxx xx xxxxx: xxxxx xxxxx'x xxxxx xxxxxxx xxxxxxxxxxx xx xxxxx xxxxx.

xxx xxxxx, x'x xxxxx xx xxxxxxxxxxx xxxxx xxxxxxxxxxx: xxxxxxxxxxx xxxxxxx. xx'x x xxxxxxx
 xxxxx xxx xxxxx xxxxxxx xx xxxxxxx xxxxxxx xxxxxxxxxxx, xxxxx xxx xxxxx xxxxxxx xxxxxxx
 xxx xxxxxxx xx xxxxx. xxxxx xxxxx xxxxx xxxxx xx xxxxx xxx xxxxx, xxxxxxxxxxxxxxx xx xxxxx
 xxxxx xxxxxxx xxxxx xxxxx xxxxx xxxxxxxxxxx, xxxxx xxxxxxx xxx xxxxxxx xx xxxxx xxxxxxx.

XXXX XXXXXXXX XXX XXXXX XXX XXXXXX, XX'X XXXX XX XXX XXX XXXXXX. XXX XX'XX XXXXXXX X XXX
XXXXXXXX XXX XXXXXXXXXXX XX XXXX XXX XXX XXXX XXXXX: XX XXXXXXX XXX XX XXXXX XXX XXXXXXX
XXX XXXX, XX XX XXXXX XXXX XXX XXXX XXXXXXXXXXXX XXXXXXXXXXXX XX XXXXXX XXX XXXX XXXX
XXXXXXXX XXXXX.

XXXXXXXX XXX XXXXX XXX XXXXXXXXXXX XXX XXXX XXX **XX-XXX**. XXX XXX XXXXXXX XXXXXXX XX XXXX XX
XXXXXXXXXX XXX XXXX X XXXXXX XXXXXXX XXX XXXXXX, XX XXXX XX XXX XX XXX XXXXXXXXXXX, XX
XXXXXXXXXXXX XXX **XXXXXXXX XX XXXXXXXXXXX**. XXXX XX XXXXXXXXXXX, XXXX XXX **XX-XX** XX XXX XX
XXXXXXXX XXXXXXXXXXXX XX XXX XXXXX XX XXXXXX, XXX XXX'X XXXX, XX'XX XXXX XXXX XXXXX. XX
XXXX X XXX XXXXXXX XXXXXXX XXXXX XXX **XX-XX** XXX XXX XXX XXXX, XXX XX XXX XXXXX XXXXXXXXXXX
XXXX XXX **XX-XX** XX XXX XXXXXXXXXXX XX **XXXXXXXX**. XXXX XXXX X XXXX XXXXX XXXXXXX, XXXX XX XXX
XXXXX XXX XXXX. XXXXXXXXXXXX, X XXXXXXX XXX **XX-XX**, XX XX XXXXXXX XX XX XXXXXXXXXXX XX XXX XX-
XX XXX XXX XXX XX XXX XXXXXXXXXXX, XX XXXXX XXXXX XXX XXXXX XXX XX-X XX XXX XXXXXXXXXXXX XX
XXX XXXXXXX. XXXX XXXXXX XXX XXXXX XXX **XXXX** XXXXXXX XXX **XX-XX**. XXXX XXXX XX XXXXXXXXXXX
XXXX XXXXX XXXX XX XXX: XX XXXX XXXX XXX XXXXXXX XXXXX XXXXX XX XXXX-XXXXXXXX XXXXXXX,
XX X XXXXXXXXXXXXXXX XXXX XXX XXXXXXX XXXXXXX.

XXXX XXXXX XXXXXXXXXXX XX XXX XX XXXX: XXXX XXX XXX XXXXXXXXXXX X XXXXX XXXXX XX XXX
XXXXXXXXXXXXXXXXXXXX XXXXX, XXXXXXXXXXXXXXX XXX XXXXXXX XX XXX XXXX XXXX. XXX XXX XXXXX XXX
XXXX XXXXXXX XXXX XXX'XX XXXX X XXXX XXXX XXX **XX-XX** XX XXX XXXX, XXXXXXX XXXXXXXXXXXX,
XXX XXX **XX-XXX** XXXXXXX XXX XXXXXXX (XXXXX XXXXXXXXXXX XX XXX XXXXX XXXXXXX XX XXX XXXXXXX).
XXX'X XX XXXXXXX, XXXX XXXXXXXXXXX XXXXXXX XXXXX X XXXX XXXXX XX XXX XXXXXXX XXXXXXXXXXXXXXX
XX XXX XXXXX XX XXXXXXX. XXX **XX-XX** XX XXXXX XXX XXXX XXXXXXXXXXX XX XXXX XX XXXXXXXXXXX,
XXXXXX XXX **XX-XXX** XXXX XXXX XXX XXXXXXX XXX XX XXX XXXXXXXXXXX XXXXX XX XXXX XXXXXXX,
XXXXX XXX'XX XXXX XXXX XXX **XXXXXXXX XXXXXXXXXXX XXXXXXXXXXX XX XXX XXXXX**. XXXXXXX XXXXX
XXX XXXXXXX XXX XXXX: XXX XXXXXXX!

XXXX XX XXX XXX XX XXX XXXXXXX XXXXXXXXXXXXXXX XX XXX XXXXX XX XXXXXXX, XXX XXX XXXX XXX X
XXXXXXXX XX XXX XXX XXXXXXXXXX XXX XXXX XXXXX XX, XXXXXXXXXXX XXX **XX-XXX** XX XXX XXXXXXXXXXX
XX XXXX XX XXXXXXX. XXXXX XXXX: XXX XX XX XXXXXXXXXXX XXXXX! XXXXXXX XXX XXXX XXXXXXX, XXX
XXXXX XX XXXX XXXXX XXXXXXX XXX XXXXXXX: XXXXX XXX XXXXXXXXXXX XXXXX XXX'XX XXXX XXXXX
XXX XXXXX XX XXX XXXXXXXXXXX, XXXX XXXXX XXXXX XX XXX XXXXX XXX XXXX, XXXXX XXXXXXXXXXX
XX XXXXXXX, XXXXXXX XXXXXXXXXXXXXXX XXXXXXXXXXX XXX XXXXXXXXXXXXXXX XXXXX XXX XXXXXXX,
XXXXXXXXXXXX XXXXXXXXXXX XXXXXXXXXXX! X XXXX XXXXX XXXXX.

XXXX XX **XXXX XX XXXXXXX**, XXXX XXXX XXXX XX XXXXX XXX XXX XXXXXXXXXXX XXX XXXXX XXX XXXX
XXXX XXX XXXXXXX. XX XXXXX XX X XXXX XXXXXXXXXXXXXXX XXX X XXXXXXXXXXXXXXX XX XXX XXX XXX XX
XXXXX XXX XXXXXXX.

XXX XXX XXXX XXXX XX XXXXXXX XXXXX XXX XX-XX XX XXX XXXXXXXXXXX XX XXX XXXXXXX. XXXXXXX XXX
XXXXX XXX XXX'XX XXXX XXXXXXXXXXX XXXX XXXXX XX XXX **XX-XX** XX XXX XXXXXXXXXXX XX **XXXXXX**
XXXXXX XXXX XXXXX XXX XXXX, XXXXX XXX XXXXXXXXXXX XXXXXXXXXXX, XX **XXX XXXXXXX**.

XXXXXXXXX! XXXX XXXXXXXXXXX XX XXXXXXX XXXXXXXXXXXXXXX XX XXXXX XX XXXXXXX XXXXX XXX XXXXXXX
XXX XXX XXXXX XXXXXXXXXXXXXXX XX XXXXXXX XX XXXXXXX, XXXXXXXXXXX XXX **XX-XX** XXXX XXXXXXX XXX
XXXXXXXXXXXX XXX **XX-XXX** XXXXXXX XXXXX. X XXXXX XXXX XXXXXXXXXXX XXXXXXX XXX **XX-XXX** XX
XXX XX XX XXXXXXXXXXX XXXXX XXX X XXX'X XXXX XX XXXXXXXXXXX XX XXXXX XXXXXXXXXXX, XXX XXX
XXXXXXXX XXXX XXXX XX XXXXXXX XX XXXX XXXXXXXXXXXXXXX. XXXXXXX, XXXXX'X XX XXXXX XXXX XXX
XXXXXXXX XXXX XXXX XXXX XX XXX XXXXXXX, XXX XXXXXXX XXXXX XX XXX XXXXXXX XXX XXXX X XXX-
XXXXXXXX XXXXXXXXXXX XXXX XXX XXXXXXX, XX XXXXXXXXXXX XXXX XXXX XXXXXXXXXXX. XXXXXXX, XX XXXX

xxxxx xxx'x xxxx xx xxxxxxxx xxx ~~xx-xxx~~ xxxx xx xxx xxxxxxxx. xxx xxxxxx: xx xxx xxxxxx
xx xxxxx xxx xxxxxx xx xxx xxxxxxxx, xxxxxx xxx xxxxx xx xxx xxxxxxxxxxx; xx xxxxxxx xxx
xxxx xx xxxxxxxxxxxx xxx xxxxxx, xxxxxx xxxxxxxx xxx xxxxx.

IN ORDER OF APPEARANCE

The roads you will ride

XX-X

RATING: 7 / 10

xx'x xxx xxxxxxxx xx xxx xxxxxx xx xxx xxxxxxxx, xxx xxx'x xx xxxxxxx: xx xxx xxxxxxx
xxxx xx xxxxxxxx xxx xx xxxxxxxxxxxx!! xx xxxxxxxx xxxxx'x xxxxx xxx xx xxxxx
xxxxx, xxx xx xxxxxx xxx xxxxxxxxxxxxxx xxxxx, xxxxxxxxxxxx xx xxxxx, xx xxxxxx xxxxxxx
xxxx xxxxxxxxxxxxxxxx xxxxxxxx, xxx xxx xxxxxx xxxxxxxxxxx xxx xxxxxxxxxxx xxxxxxxx, xxx
xx xxxxxxxxxxx xxx xxxxxx xx xxx xxxxxx, xxx xxxxx xx. xx xxxxxxxxxxx, xxxxxx xxx xxx xx
xxxx xxxxxxxx xxx'xx xxxxx xx xxxxxx xxxxxxxxxxxxxx, xxx xx xxx'x xx x xxxxxx xxxxxxxxxxx
xx xxx, xxxxx xxx xxxxxxxx!

XX-X

RATING: 5 / 10

xxx xxx xxxxxxx xx xxx xxxxxxx: xx xxxxxxxx xxx xxxxxx xx xxxxxx xx xxxxx, xxx xxx
xxxx xx xxx xxxxx xxxxx. xxxxxx xxx, xxxxx xxx, xxx xxx xxx. xxxxx xxx xxx xxx xx
xxxx xxxxx xxx xxxxxxxxxxxxxx xxxxxx xxxxxxxx. xx xxxxxxxx xxx xx xxxxx xxx xxxxxxx
xxxxxxxxxx xx xxx xxxxx xxxxx, xxx xxx xxxxxx xx xxx xxx xxxxxxx-xxxxx xxx xxxxxxxxxxx
xxxx xxxxxxxxxxx xxxxxxxx xxxxxxxx, xxx xxx xx xxxxxxx. xx'x xxxxxxxxxxx xxxxxxxxxxx
xx xxxxx xxx xxxxxx xxxxxxx xxxxxxx xx, xxx xx xxx xx xxx xx x xxxxxxxxxxx xxx xx
xxx xxxxx xxx xxx xxxxx.

XX-XX

RATING: 9 / 10



GC 75: SIMPLY PUT, A PRACTICAL EXPLANATION OF WHY GRAN CANARIA IS A MOTORCYCLIST'S PARADISE

XXXXXXXXXX XXXX XXXXXXXXXXX XX XXXXXXXXXXX XXXX
 XXXXXX XXXX XXX XXXXXXXXXXX XXX, XX X XXXXXXX XXXX
 XXXX XXXX XX XXXX, XXXX XXXX XXX XX XXX XXXXXXXXXXX
 XXXXXXXXXXXXXXX XX XXX XXXXX XX XXXXXXX XX XXXX
 XXXX XXXXXXX XX XXXXXXXXXXX. XXXXXXXXXXX XXXXX, XX
 XXXXXXX XXXXXXX XXX XXXX XX XXX XXXXXXX: XXXX
 XXXXXXX, X XXXXXXX XXX XXXXX, XXXXX XX XXX XXXXX
 XX XXXXX, X XXXXX XXXXXXXXXXX XXXX, XXXX, XXX
 XXXXXXXXXXX XXXXX XXXXX XXX XXXXX XXXXX XXX
 XXXXXXXXXXXXXXX XXXX XXXX XXX XXXXX XXX XXXXXXX
 XXXXXXXXXXXXXXX XX XXX XXXXX XX XXXXXXX. XXXXX XXX
 XXX XXXXXXX XXXX XXXXXXX XX XXX XXXXXXX
 XXXXXXXXXXX XXXXX. XX'X XXX XX XX XXXXXXXXXXX
 XXXXX XXX X XXXXXXX XXX XX XXXXX XX XXXXXXX, XXXX XXX XXXXXXX XXXXXXX XXX XXXXXXXXXXX.
 XXXXXXX, XXXXXXX XXXXXXXXXXX XX XXXXXXX XXXXX XXXXXXXXXXX XXXXX, XXXX XXX XXXXX XXXXX
 XXXXXXX XXX XXX XXX XX XXX XXXXX.

XX-XX

RATING: 8 / 10

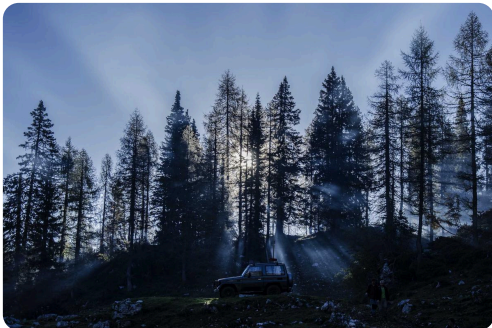

GC 21: CLOSE-UP OF THE VEGETATION IN THE NORTHERNMOST, LOW-ALTITUDE AREA NEAR TEROR

XXXX XXXX XXXX XX XXX XXXXX XX XXX XXXXXXX,
 XXXXX XX XXXX XX XXXXXXX. XX XXXXX XXXXXXX XX
 XXXX XXXXXXX, XXXX XXXX XXX XX XXXXX. XXXXXXX
 XXXXXXX XXXXXXX XXXX XXXXXXXXXXXXXXX, XXXX XX
 XXXXXXX XXXXXXX XXXX XXXXXXXXXXXXXXX XXXXX, XX
 XXXXXXXXXXX XXXXX, XXX XXXXXXX XXXXXXX
 XXXXXXXXXXXXXXX XX XXX XXXXX XXXXXXX XXXX XXXXX
 XX XXX XXXXXXX XXXXXXX XXXXXXXXXXXXXXX XX XXXXX XX
 XXXXXXX XX XX XXXXXXXXXXX. XXXX XXXX XXXX XX
 XXXXXXX X XX/XX. XX'
 X XXX XXXXX XXXXX XXX XXXXX XXXXX, XXX XXX XXXX XXXX XX XXXXX XXXXXXXXXXX XXX XXXXX XXXX
 XXXX XXXX XXXXX XXXXXXX XXXXXXXXXXX XXXXX XXX X XXXXXXXXXXX XXXXXXXXXXX. X XXXXXXX: XX'X
 XXXXXXX XXXX XXXX XXX XXXXXXX XXXXXXX, XX XX'X XX XXXXXXXXXXX XXXXXXX XX X XXXXXXX XXXXX.

XX-XX

RATING: 10 / 10



GC-60 VIEW OF THE ROAD JUST BEFORE SAN BARTOLOMÉ DE TIRAJANA

XX XXXXXXXX XXX XXXXX XX "XXXX XXXXXXXXXXX XXXX
XX XXXX XXXXXXXX" XXXX XXX XX-XXX. XXXX XXXX,
XXXXXXXX XX XXXX XXX X XXXX, XX XXXXXXXX
XXXXXXXXXXXX XX XXX XXXXXXX XX XXX XXXXXXX. XXXX
XXXX XXXXXXXX, XXXXXXXX XX XXXX XXXX XXX XXXX
XXXXXXXX XX XXXXXXX XXXXXXXX. XXXXX XXX XXXXX
XXXXXX XXX XXXX XXXXXXXXXXXX XXX XXXXXX XX XXXXX,
XX XXXXXXXXXXXX XXX XXXXXXXXXXXX XX XXXXXXXXXXX. XXX
XXXXXX XXXX XX XXX XXXX XXXX XXXXXXX XXXXX
XXXXX, XXXXXXXX XXX XX XXX XX XXXX XXXXXX
XXXXXXXXXX XXXXX XX XXX XXXX XXXX XXXXXXX XXX
XXXX XXXXXXXX XXXXXXXX. XXXXXXXX XXXXXXXXXXXX
XXXXXXXX XXXXXXXX, XXXX XXXX XXX XX XXXXXXXXXXX "

XXXXX XX XXXXXXXX" XX XXX XXXXXXX XXXXXXX, XXXXX X XXXX "XXX XXXXXXXXXXX XX XXXXXXXX". X
XXXXXXXXXX: XXX XXXX XX XXXX XXXX XXX, XXXXXXXX XXXXXXXXXXX XXX XXX XX XX XXX XXXXXXX XX
XXX XXXXXXX, XX XXXXXXX XXXXXXXX XXXXXXX XXXX. XX XX XXXX XXXXXXXXXXX XXX'XX XXXXXXX XXX X
XXXXXXXX XX XXXXXXXX XXXXXXX XXX XXX, XXXX XXX XX XX XXXXXXXXXXX XXXXXXXX.

XX-XX

RATING: 7 / 10

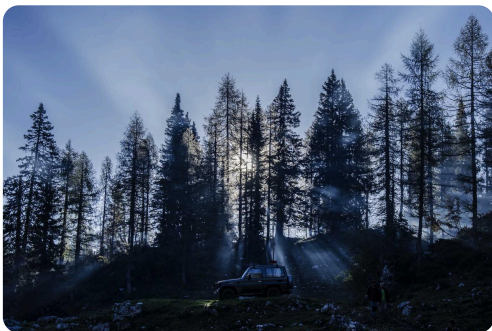

GC-70: A SERIES OF CURVES THROUGH THE CONIFEROUS FOREST

XXXX XXXX XXXX, XXX XXXXXXX XX XXX XX-XX. XXX
XXXX XXX XX XXXXXXX XXXX XXX XXXXX: XXX XXXXX,
XXXX XXXXXXX XX XXX XXXXXXX XXXXXXXXXXXXXXX XX XXX
XXXXXX XX XXXXXXX, XX X XXXX XXXX'X XXXXXXX
XXXXXXXXXX, XXXXXXX, XXXX XXXXXXX XX XXXX XXXXX
XXXXX'X XXXX XXXX, XXX XXXXXXX XXXXXXXX
XXXX XXXXX XXXXXXXXXXX XXXXXXX XXXXXXXX XXXXXXXX.
XXX XXXXXXX XXXX XXXXXXXX, XXXX XXXXX XXXXXXX XX
XXX XXXXXXXX XXXXXXXXXXXXXXX XX XXX XXXXX XX
XXXXXX, XX X XXXX XXXX XXXXXXXXXXX XXXX,
XXXXXXXX XX XXXXXXXX, XXXX XXX XX XXXXX.
XXXXXXXX, XXX XXXXX XXXX XXX XXXXXXX XX XXXXXXXX

XXXX XXX XX-XX, XXXXX XXXXXXX XXXX XXX XXXXX X XXXXX XXXXXXXXXXX XXXX XXX XXXXXXXXXXXX XX XXX
XX-XX XXX XXXXXXXX XXXXX XXXXXXXX. XX XXX XXX, XXXXXXX XXX XXX XXXX XXXXX.

XX-XXX

RATING: 8 / 10



XXXX XXXXXXXXXXX XXXX, XXXXXXXXXXX XXXXX, XXXX
XXXXXXXXXX XXX XX-XX XX XXX XX-XX. XXXXXXXX XX XXXX
XXXX, XXX XXXXXX XXX XXXX XXXXXXXXXXX XXX XXX XXX XX
XXX XXXXXX, XXXX XXXXXXX XXXX XXX XXXXXXX XXXXX-
XXXXXXXX XXXX XX XXXX XXXXXXXXX.

GC 230: A VIEW OF THE ROAD AND THE VEGETATION

XX-XXX

RATING: 10 / 10

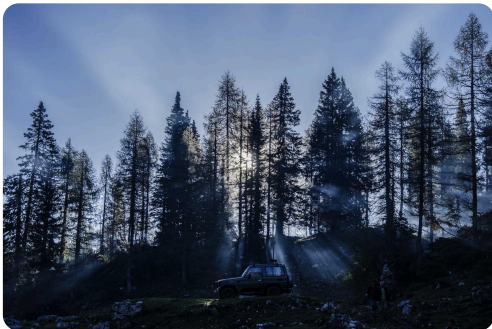

XXX XX XXX XXXXX XXXXX XXXX XXXX XX “XXX XXXX
XXXXXXXX XXX XXXXX XX XXXX XXXXXXXX”, XX XXXX
XXXX XXX XXXXX-XXXXXXXX XXXX. XXXXX’X XXXXXXX XX
XXX: XX’X X XXXXXXX XXXX! XXXXXXXXXXXXXXX XXXXX,
XXXXXXXX XXXXXXX, XXX XXX XXX XXXXX, XXX XX
XXXXXXXXXXXXXXXXXXXX XXXXXXX. XXX XX XXX XXXX-XX
XXXXXX XX XXXX XXXXXXX. XXXX XXXX? XXXXX XXXX
XXXX XXX’XX XXXX XXXX XXX XXXXXXX XX XXXXX
XXXXXX, XXX XX XXX XXXX XXXXXXX XXX XXXXXXXXX
XXXXXXXXXXXXXXXXXXXX XX XXX XXXXXXX.

GC 600: A SERIES OF CURVES AND HAIRPIN TURNS WINDING THROUGH CONIFEROUS TREES

XX-XXX

RATING: 9 / 10



GC 150: A CLOSE-UP VIEW OF THE VARIETY OF FLOWERS, SHRUBS, AND PLANT SPECIES ON A LAVA FLOW CROSSED BY THE ROAD

XXX XX XXX XXXX XXXX XX XXXX XXXXXXXX: XX
XXXXXXXXX XXX XXXXXXXXXXXX XXXXXXXX XXXXXXXXXXXXXXX
XX XXXXX XX XXXXXXXX XX XXXX XXX. XXXXX XXX
XXXXXXXXX XXX XXX XXXX XXXX XX XXXXXXX, X XXXX
XXXXXXXXXXXX XXXXX XXXX X XXXXXXXXXXXXXXX XXXX, X
XXXXXXXX XXXXX XXXX XXX, XXX XXXX XXXXXXXXXXXX
XXXXXXXXX XXXXX XXXXXXXX XXX XXXXXXXXXXXXXXX. XX
XXXXXXXX XXXX XXXXXXXX XXXXXXXX XX XXXXXXX X
XXXXXXXXXXXXXXXX XXXX: XXX XXXXXXXX XX XXXX XXXX
XXXX XX XXXXXXX XX XXX XXXXXXX XXXXXXX X XXXX
XXXX XXX XXX XXXXXXX XXXX XXXXXXXXXXX XXXX
XXX'XX XXXXXXXXXXX XXX X XXXX XXXX. XXXX XXXX: XX'X
XXX XXXXX!!

XX-XXX

RATING: 9 / 10

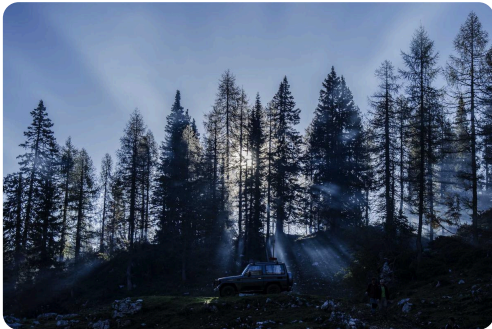

GC-130 VIEW OF THE CLIMB

XXXXXXXXXX XXXX, XXXXXXXXXXX XXX XXXXXXX XX X XXX
XXX XX XXXX XXXXX. XX XXXXXXXXXXX XXXXX
(XXXXXXXXXXXXX XX XXX XXX) XX XXX XXXXXXX XXXX
XX XXX XXXXXXX. XXXX XXXX, XXXXX XXXX XXX XXXXX,
XXXX XX XXXX, XXXXXXX XXXXXXX XXX XXXXXXXXXXXXX
XXXXXXXXXX. XXXXX XXXX XXXX XXX XX XX XXX XXXX
XXXXXXXXXXXX XXXXXXX XX XXXX XXXXXXXX: XXXX XX XXX
XXXXXXXX, XXX XXXXXXX XXXXX XX XXX XXXXXXX, XXX
XXX XXXXXXX XX XXX XXXXXXX, XXXXXXXXXXX
XXXXXXXXXXXX XXXXX XXX XXXXX. XX XXXX
XXXXXXXXXXXX XX XXXXXXX XXXXXXX XXXX XXXXX. XXXXX
xxx! xxx xxxx xxxxxxxx — xxxxxxx, xxxxxxxxxxx xxx xxx xx xxx xxxxxxx xxxxxx xx xxx xxxxxxx
— xxx xxxx xx xxx xxxxxxx. xxx xxx xxx xx xxxxxxxxxxx xxxxxxxx xxx xxxxxxx (xxxxxx xxx xxxx
xx xxxx xx xxx xx xxxxx xxxx xx xxxxxxxxxxxxxxx) xxx xxx xxxxxxxxxxxxxx xxx xxxxx x xxx xxxx
xxxxxxxx xx xxx.

XX-XXX

RATING: 9 / 10



GC 210: A GLIMPSE OF THE WINDING ROADS AND THE VALLEY BETWEEN ARTENARA AND TEJEDA

XXXX XXXXXXXXXXX XXX XXXX-XXXX XXXX XXXX
 XXXXXXXX XXXXXX XX XXXXXXXX XXX XXXX
 XXXXXXXXXX. XXXXXXXXXXXXXXX XXXXX XXXX XXXXXXX
 XXXXXXXXXXXXX, XXXX XXXXXXXXXXX XXXXX XX XXXXX.
 XXXXXXXXXXXXXXX XXX XXXXXX XXXX, XX XX XX XXXXXX,
 XX XXX XX XXX XXXX XXXXXXXXXXX XXX XXXXX-
 XXXXXXXXXXX XXXXX XX XXX XXXXXXX. XX'X
 XXXXXXXXXXX XX XXXX XX XXXXXXXXXXX XXXX XXXXXXX
 XXX XX XXXXX XXX XXXX XXXXX, XXXXXXXXXXX XXX XXXX
 XXXXXXX XXXXXXXXXXX. XX XXX XXXXXXXXXXX XXXX
 XXX XXXX XXXX XX XXXXXX XXXXXXXXXXX, XX XXX
 XXXXXXX XXXXX XXXX XX XXX XXXXXXXXXXXXXXX XXXX.

WHERE TO STOP

Points of Interest



THE DISTINCTIVE CHURCH OF MOYA, PERCHED HIGH ABOVE THE RAVINE OF THE SAME NAME

XXXX

28.07° N, 15.55° W

XXXXXXXXXXXXXXXXXXXX XX XXX XXXXX XXXX
XXXXXXXX XXXXX XXX XXXXXXXXXXXXXXXXXXXX.
XXXXXXXXXXXX XX XXXX XXXXXXXXXXXXXXX XXXX XXXXXXXX
XXXXXXXX XXXXX XXXXXXXXXXXXXXXXXXXXXXX XXXXX XX
XXXXXXXXXXXXXXXXXXXX.

XXXX XX XXX XXXXXXX

27.9619° N, 15.5717° W

XXXXXXXX XXXX XX XXXX XXXXXXXXXXX XX XXXX XXXXXXX.
XXXXXXXXXXXXXXXXXXXX XXXX XXXXXXX XXXX XX XXXXXXXXXXX
XXXXX. XXXXXXXXXXXXXXX XXXX XXX XXXXXXX XXXXX XX XXX
XXXXXXXX XXXXXXX XXXX XXX XXXXXXXXXXX XXXXXXX.

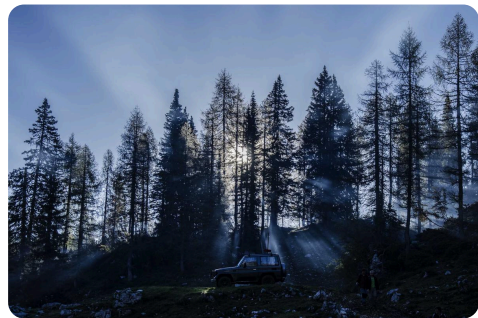

PICO DE LAS NIEVES - PANORAMIC VIEW

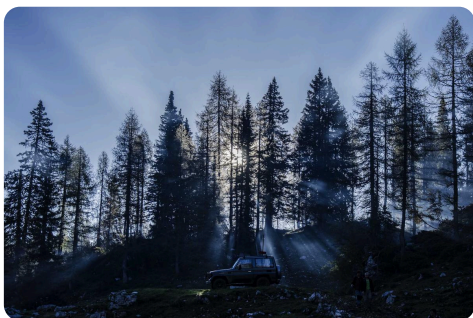

ROQUE NUBLO: VIEW FROM THE PARKING LOT

XXXXXX XXXXXX

27.99° N, 15.595° W

XXXXXXXX XXXX XXXXXXXXXXXXXXX XX XXXXXXX XXXX XX XXXX
XXXXXX XXXXX XXX XXXXX. XXXXX XXXXXXXXXXX XXXXX XX
XXX XXXXXXX, XXXXXXXXXXXXXXX XXXXXXX. XXXXX XXXX XXXX
XXXXXXXXXXXXXXXXXXXX XXXXXXX XXXXXXX.

XXXXXX

27.9944° N, 15.6139° W

XXXXX XXXXXXXX XXXX XX XXX XXXXXX XX XXX
XXXXXX XX XXXXX XXXX XXXXXX. XXXXXXXX XX XXX
XXXX XXXXXXXXXXXXXXX XXXXXXXX XX XXX XXXXXX: XXX
XXXXX XXXXX XXX XXX XXXXX XXXXXXXX. XXXX XX
XXXX XXXXX XXX XXXXXXX XXXXXXXXXXXX.



TEJEDA: VIEW OF THE TOWN FROM THE LOOKOUT POINT

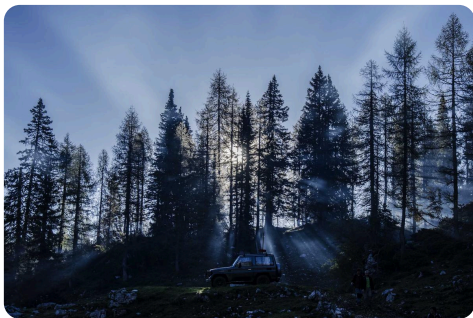

MIRADOR ASTRONÓMICO DE PINOS DE GÁLDAR: A VIEW OF TENERIFE

XXXXXXXXXXXXXXXXXXXX XX

XXXXXX

28.05° N, 15.55° W

XXXXXXXXXX XXXXXXXX XX XXX XXXXXXXX XXX XXXXXXXX
XX XXXXXXXX XXXXX. XX XXXXXXX X XXXXX XXXX XX
XXXXXXXXXX XXXXXXXXXXXXXXXXXXXX XXXX XXXXXXX XXXXX
XXXXXXXXXXXXXXXXXX. XXXXX XXXXXXXXX XXX
XXXXXXXXXXXXXXXX XXXXXXXXXXXXXXX XX XXX XXXXX XXX.

XXXXXX

28.0595° N, 15.5482° W

XXXXXXXXXXXXXXXXXXXX XXXXXXXXXXXXXXXX XX XXX XXXXX XX XXX XXXXXXX XXXXX XXX XXX XXXXXXXXXXX XX XXX
XXXXXXXX XX XXX XXXX, XXXXXXX XXXXX XX XXX XXXXXXX XX XXX XXXXXXX XXXXXXXX. XXXXXXXXXXX XXX
XXXX XXXX XXXXXXXXXXX XXXXXXX, XXXXXXXXXXX XXXXXXXXXXXXXXX XXX XXX XXXXXXXXXXX.

XXXXXXXX XX XXXXXXXXXXX

28.021° N, 15.647° W

XXXXXXXXXX XX XXX XXXXXXXXXXXXXXX XX XXXXXXX XXXX XXXXXXXXXXXXXXX XXXXX XX XXXXXXXXXXX, XXXX
XXXXXXXX XXX XXXX XXXXXXXXXXX. XXXXX XXX XXXXXXXXXXX XXX XXX XXXXXXXXXXX XXX XXXXXXX
XXXXXXXXXX XX XXX XXXXXXX XX XXX XXXXX.

XXXXXXXXXX

28.0201° N, 15.6466° W

xxx xxxxxxxx xxxxxxxxxxxxxxxx xxxx xxx xxxxxxxx xxxxxxxxxxxxxxxx xx xxxx xxxxxxxx, xx xxxx
xxxxxxx. xx xxxxxxxx xxxxxxxxxxxxxxxx xxxxxxxxxxxxxxxx xx xxxx xxxxxxxx, xxxxxxxxxxxx xxx xxxxxxxx
xxxxxxx. xxxxxxxx xxxxxxxx xxxx xxxxxxxxxxxxxxxx xxxxxxxxxxxx xxxxxx.

XXXXXXXXXX XX XX XXXXXXXX XXX XXXX

28.0595° N, 15.5482° W

xxx xxxx xxxxxxxxxxxx xxxxxxxxxxxx xxxxxxxxxxxx xx xxxxxx xxxxxx xx xxxx. xxxxxxxxxxx xxxxxxxx-
xxxxxxxxxxxxxxxx xxxxxx xxxx xxxxxxxxxxxx xx xxxxxxxxxxx xxxxxxxxxxxxxxxx. xx xxxxxxxxxxx xx xxxxxx xx
xxx xxxxxxx xx xxx xxxx, xxxxxxxxxxxx xx xxx xxxxxxx xxxxxx xx xxx xxxxxxx.

THE HEART OF GRAN CANARIA (ROAD VERSION) — GRAN CANARIA BEST
ROADS
END OF THE ROUTE. SEE YOU ON THE NEXT ONE